

PRODUCT REFERENCE		STATE CONTRACT	
Product code:	TH-001	Description:	Barstools
		Quantity:	43
Location(s):	Outdoor Terrace - Sign Bar - 03.41.03		
PRODUCT INFORMATION		SPECIFICATION TYPE	
		PRODUCT SPECIFIC	BASIS OF DESIGN
Manufacturer:	Adriano Seating	Local Representative:	Jody Schetcher 805 501-0798
Product name:	Mediterranean	Style / Product number:	BMED-500
Overall Dimensions:	30"h x 17"w x 17"d	Photo:	
Description:			
FINISH INFORMATION			
Metal Finish	Stainless Steel		
Woven Finish	Singapore Coffee 1205-4032		

PRODUCT REFERENCE		STATE CONTRACT	
Product code:	TH-004	Description:	Square Seat
		Quantity:	52
Location(s):	Outdoor Terrace - Sign Bar - 03.41.03		

PRODUCT INFORMATION		SPECIFICATION TYPE	
Manufacturer:	Fong Brothers Company or	Local Representative:	Lienanh Thanhtrong 323 583-6481 x 109
Product name:	Custom outdoor seating	Style / Product number:	Custom
Overall Dimensions:	19 1/2" w x 19 1/2"d x 16"h	Photo:	
Description:	Custom woven resin wicker seat with upholstered seat cushion and metal legs		

FINISH INFORMATION			
Metal Finish			
	Manufacturer:	Aborite - laminate	
	Color:	Brushed Silver Metal	
	Code:	MT-201	
Woven Finish	Natural		
Upholstery			
	Manufacturer:	Architex	
	Pattern:	Bubbles	
	Color:	Pomegranate	
	Content:	100% Acrylic	

PRODUCT REFERENCE		STATE CONTRACT	
Product code:	TH-005	Description:	Corner Seat
		Quantity:	4
Location(s):	Outdoor Terrace - Sign Bar - 03.41.03		

PRODUCT INFORMATION		SPECIFICATION TYPE	
Manufacturer:	Fong Brothers Company or	Local Representative:	Lienanh Thantrong 323 583-6481 x 109
Product name:	Custom outdoor furniture	Style / Product number:	Custom
Overall Dimensions:	42"w x 42"d x 31"h back (16"h seat)	Photo:	
Description:	Custom woven resin wicker corner chair module with upholstered seat cushion and metal legs		

FINISH INFORMATION

Metal Finish
Manufacturer: Aborite - laminate
Color: Brushed Silver Metal
Code: MT-201

Woven Finish Natural

Upholstery
Manufacturer: Architex
Pattern: Bubbles
Color: Pomegranate
Content: 100% Acrylic

PRODUCT REFERENCE		STATE CONTRACT	
Product code:	TH-006	Description:	Center Seat
		Quantity:	16
Location(s):	Outdoor Terrace - Sign Bar - 03.41.03		

PRODUCT INFORMATION		SPECIFICATION TYPE	
Manufacturer:	Fong Brothers Company or	Local Representative:	Lienanh Thanhtrong 323 583-6481 x 109
Product name:	Custom outdoor furniture	Style / Product number:	Custom
Overall Dimensions:	36"w x 37"d x 31"h back (16"h seat)	Photo:	
Description:	Custom woven resin wicker center chair module with upholstered seat cushion and metal legs		

FINISH INFORMATION

Metal Finish
Manufacturer: Aborite - laminate
Color: Brushed Silver M
Code: MT-201

Woven Finish Natural
Upholstery

Manufacturer: Architex
Pattern: Bubbles
Color: Pomegranate
Content: 100% Acrylic

PRODUCT REFERENCE		STATE CONTRACT	
Product code:	TH-007	Description:	Bench
		Quantity:	1
Location(s):	Outdoor Terrace - Sign Bar - 03.41.03		

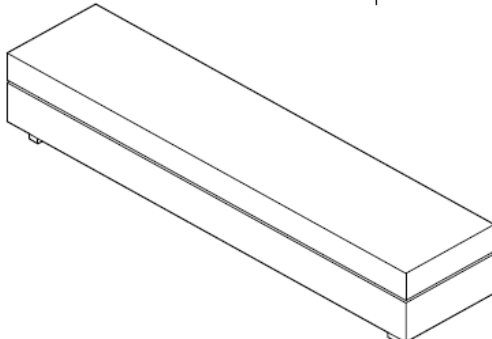

PRODUCT INFORMATION		SPECIFICATION TYPE	
Manufacturer:	Fong Brothers Company or	Local Representative:	Lienanh Thanhtrung 323 583-6481 x 109
Product name:	Custom outdoor furniture	Style / Product number:	Custom
Overall Dimensions:	14'4"w x 20"d x 16"h	Photo:	
Description:	Custom woven resin wicker bench with upholstered seat cushion and metal legs		

FINISH INFORMATION

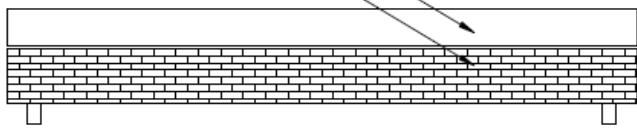
Metal Finish
Manufacturer: Aborite - laminate
Color: Brushed Silver Metal
Code: MT-201



Woven Finish Natural
Upholstery
Manufacturer: Architex
Pattern: Bubbles
Color: Pomegranate
Content: 100% Acrylic

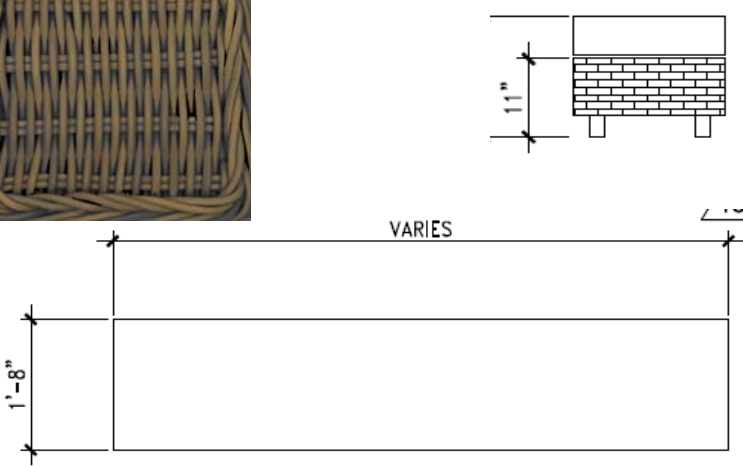



PRODUCT REFERENCE		STATE CONTRACT	
Product code:	TH-008	Description:	Bench
		Quantity:	1
Location(s):	Outdoor Terrace - Sign Bar - 03.41.03		

PRODUCT INFORMATION		SPECIFICATION TYPE	
Manufacturer:	Fong Brothers Company or	Local Representative:	Lienanh Thanhtrng 323 583-6481 x 109
Product name:	Custom outdoor furniture	Style / Product number:	Custom
Overall Dimensions:	12'4"w x 20"d x 16"h	Photo:	
Description:	Custom woven resin wicker bench with upholstered seat cushion and metal legs		

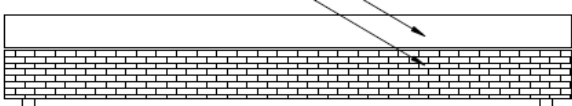

FINISH INFORMATION

Metal Finish
Manufacturer: Aborite - laminate
Color: Brushed Silver Metal
Code: MT-201



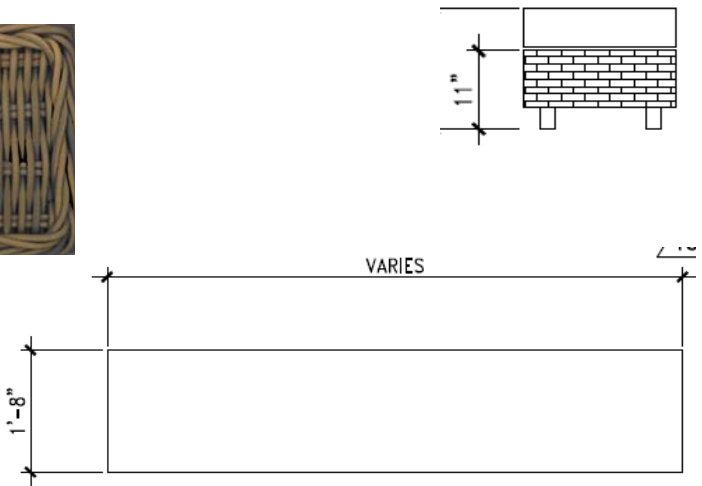

Woven Finish Natural
Upholstery

Manufacturer: Architex
Pattern: Bubbles
Color: Pomegranate
Content: 100% Acrylic

PRODUCT REFERENCE		STATE CONTRACT
Product code:	TH-009	Description: Table Quantity: 27
Location(s):	Outdoor Terrace - Sign Bar - 03.41.03	

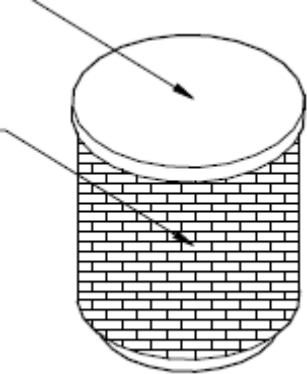
PRODUCT INFORMATION		SPECIFICATION TYPE	PRODUCT SPECIFIC	BASIS OF DESIGN
Manufacturer:	Fong Brothers Company or	Local Representative:	Lienanh Thanhtrong 323 583-6481 x 109	
Product name:	Custom outdoor furniture	Style / Product number:	Custom	
Overall Dimensions:	25" diameter x 29"h	Photo:		
Description:	Custom round table with stone top, woven resin wicker and metal base			

FINISH INFORMATION	
Metal Finish:	Stainless Steel
Woven Finish:	Natural
	
Top Finish:	
Manufacturer:	Silestone
Pattern:	Tebas
Color:	Black
Texture:	Leather
	
	

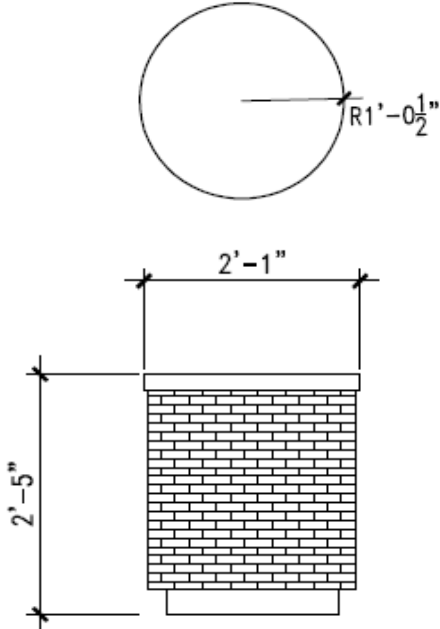
PRODUCT REFERENCE		STATE CONTRACT I	
Product code:	TH-010	Descriptor	Table
		Quantity:	6
Location(s):	Outdoor Terrace - Sign Bar - 03.41.03		



PRODUCT INFORMATION		SPECIFICATION TYPE	
		PRODUCT SPECIFIC	BASIS OF DESIGN
Manufacturer:	Fong Brothers Company or	Local Representative:	Lienanh Thantrong 323 583-6481 x 109
Product name:	Custom outdoor furniture	Style / Product number:	Custom
Overall Dimensions:	5'5"w x 20"d x 12"h	Photo:	
Description:	Custom rectangular table with woven resin wicker and metal base		

FINISH INFORMATION			
Metal Finish			
Manufacturer: Aborite - laminate			
Color: Brushed Silver Metal			
Code: MT-201			
Woven Finish	Natural		
Top Finish			
Manufacturer: Silestone			
Pattern: Tebas			
Color: Black			
Texture: Leather			

PRODUCT REFERENCE		STATE CONTRACT I	
Product code: TH-011		Descriptor Planter Rail Seat	
		Quantity: 5	
Location(s): Outdoor Terrace - Sign Bar - 03.41.03			
PRODUCT INFORMATION		SPECIFICATION TYPE	
		PRODUCT SPECIFIC	BASIS OF DESIGN
Manufacturer: Fong Brothers Company or		Local Representative: Lienanh Thanhtrng	
		323 583-6481 x 109	
Product name: Custom outdoor furniture		Style / Product number: Custom	
Overall Dimension: 32"h back x 39"h rail (16"h seat)		Photo:	
Description: Custom woven resin wicker seating and planter module with upholstered seat cushion and r			
FINISH INFORMATION			
Metal Finish Manufacturer: Aborite - laminate Color: Brushed Silver Metal Code: MT-201			
Woven Finish Natural			
Upholstery Manufacturer: Architex Pattern: Bubbles Color: Pomegran Content: 100% Acry			

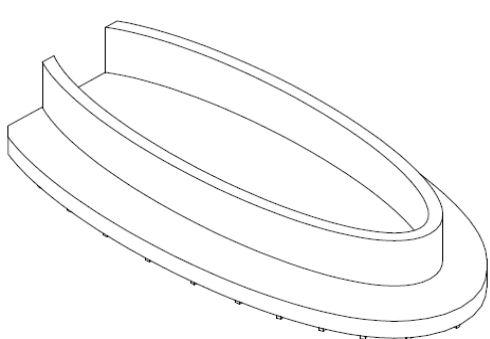
PRODUCT REFERENCE		STATE CONTRACT	
Product code:	TH-012	Description:	Curved Seat
Quantity:		Quantity:	1
Location(s):	Outdoor Terrace - Sign Bar - 03.41.03		

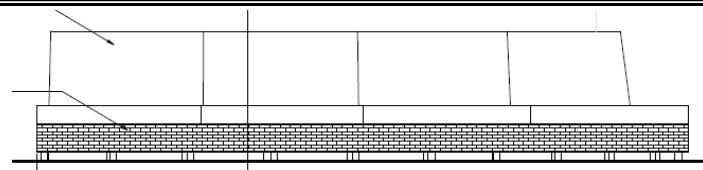
PRODUCT INFORMATION		SPECIFICATION TYPE		PRODUCT SPECIFIC	BASIS OF DESIGN
Manufacturer:	Fong Brothers Company or	Local Representative:	Lienanh Thantrong 323 583-6481 x 109		
Product name:	Custom outdoor furniture	Style / Product number:	Custom		
Overall Dimension:		Photo:			
Description:	Custom woven resin wicker curved seating module with upholstered seat cushion and metal legs				

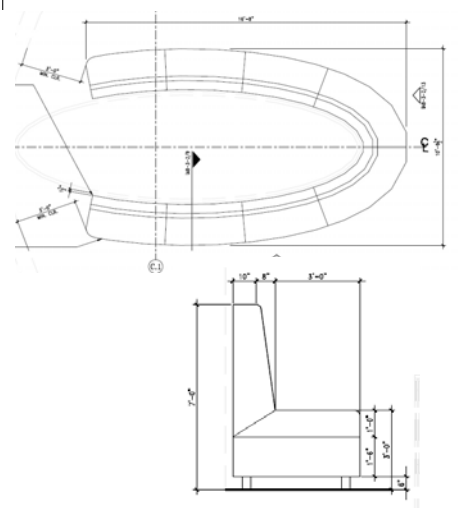
FINISH INFORMATION					
Metal Finish					
Manufacturer:		Aborite - laminate			
Color:		Brushed Silver Metal			
Code:		MT-201			
Woven Finish		Natural			
Upholstery					
Manufacturer:		Architex			
Pattern:		Bubbles			
Color:		Pomegranate			
Content:		100% Acrylic			
					

PRODUCT REFERENCE		STATE CONTRACT I	
Product code:	TH-013	Descriptor	Trash Receptacle
		Quantity:	4
Location(s):	Outdoor Terrace - Sign Bar - 03.41.03		
PRODUCT INFORMATION		SPECIFICATION TYPE	
		PRODUCT SPECIFIC	BASIS OF DESIGN
Manufacturer:	Frontgate or equal	Local Representative:	www.frontgate.com 866-263-9850
Product name:	Outdoor Trash Receptacle	Style / Product number:	19590
Overall Dimensions:	22"w x 22"d x 40"h	Photo:	
Description:	Wicker Weave Trash Can is actually made of long-lasting Viro™ resin. This highly durable resin wicker is woven over a powdercoated aluminum frame to ensure this outdoor garbage can will		
ADDITIONAL INFORMATION			
<p>Lift-off trash bin lid offers easy access 24-gallon mesh insert remov Non-skid base keeps it in plac UV-resistant wicker fibers re</p> <p>FINISH Standard</p>			



PRODUCT REFERENCE		STATE CONTRACT I
Product code:	TH-014	Descriptor Shooting Game Quantity: 5
Location(s):	Kids Zone 05.20.01	

PRODUCT INFORMATION		SPECIFICATION TYPE	PRODUCT SPECIFIC	BASIS OF DESIGN
Manufacturer:	Ice	Local Representative	Brady Distributing	
		Tim Paukner	407 872-1666	
Product name:		Style / Product number		
Overall Dimensions		Photo:		
Description:	NBA Licensed			

ADDITIONAL INFORMATION
With Orlando Magic logos



PRODUCT REFERENCE		STATE CONTRACT I	
Product code:	TH-015	Descriptor	Video Game Table
		Quantity:	4
Location(s):	Kids Zone 05.20.01		
PRODUCT INFORMATION		SPECIFICATION TYPE	
		PRODUCT SPECIFIC	BASIS OF DESIGN
Manufacturer:	Namco Bandai	Local Representative:	BMI Gaming 800 746-2255
Product name:	Cocktail Table Video Game	Style / Product numl	
Overall Dimensions	27"wx 27"d x 29"h	Photo:	
Description:	Ms. PacMan, Galaga and Pac-Man Class Of 1981 20th Anniversary Reunion Edition		
ADDITIONAL INFORMATION			
<p>19" Commercial Video Monitor - Commercial Model comes with (2) Working Coin Mechanisms that accepts quarters for play, but can be set on</p>			



PRODUCT REFERENCE		STATE CONTRACT I	
Product code:	TH-016	Descriptor	Bean Bag Chair
		Quantity:	4
Location(s):	Kids Zone 05.20.01		
PRODUCT INFORMATION		PRODUCT SPECIFIC	BASIS OF DESIGN
Manufacturer:	BeanBagChairStore	Local Representative:	800 380-5056
Product name:	Basketball Bean Bag Chair	Style / Product numl	1283-b6f
Overall Dimensions	32"l x 30"w x 23"h	Photo:	
Description:	durable orange vinyl		
ADDITIONAL INFORMATION			
<p>PVC Vinyl, Polystyrene Bead Double stitched with double overlapping folded seam Double zippered bottom for added security Childproof safety lock zipper pulls</p>			



PRODUCT REFERENCE		STATE CONTRACT I	
Product code:	TH-017	Descriptor	Dodge Balls
		Quantity:	5 sets of 6
Location(s):	Kids Zone 05.20.01		
PRODUCT INFORMATION		SPECIFICATION TYPE	BASIS OF DESIGN
Manufacturer:	Athletic Stuff or equal	PRODUCT SPECIFIC	
Product name:	Rhinoskin Dodge Balls	Local Representative:	www.athleticstuff.com 877-406-0607
Overall Dimensions	6" diameter	Style / Product numl	RXD6SET
Description:	Multicolored set of 6 dodgeballs. Soft, high quality construction with durable skin takes the sting out of impact	Photo:	
ADDITIONAL INFORMATION			



PRODUCT REFERENCE		STATE CONTRACT	
Product code:	TH-018	Description:	Light Fixture
		Quantity:	6
Location(s):	Outdoor Terrace - Sign Bar - 03.41.03		

PRODUCT INFORMATION		SPECIFICATION TYPE	
Manufacturer:	Fong Brothers Company or	Local Representative:	Lienanh Thantrong 323 583-6481 x 109
Product name:	Custom lighting fixture	Style / Product number:	Custom
Overall Dimensions:	Base 33" dia. X 29"h Overall 102" h	Photo:	
Description:	Custom round table with stone top, woven resin wicker and metal base brushed aluminum lamp stand and upholstered shade		

FINISH INFORMATION			
Metal Finish	Stainless Steel		
Woven Finish	Natural		
Upholstered Shade			
Manufacturer:	Architex		
Pattern:	Bubbles		
Color:	Pomegranate		
Content:	100% Acrylic		
Top Finish			
Manufacturer:	Silestone		
Pattern:	Tebas		
Color:	Black		
Texture:	Leather		

PRODUCT REFERENCE		STATE CONTRACT I	
Product code:	THG-019	Descriptor	Ball Racks
		Quantity:	3
Location(s):	Kids Zone - 05.20.01		
PRODUCT INFORMATION		SPECIFICATION TYPE	
		PRODUCT SPECIFIC	BASIS OF DESIGN
Manufacturer:	Spalding	Local Representative:	Ruey Peck (614) 476-6003
Product name:	Ball Rack	Style / Product number:	411-602
Overall Dimensions		Photo:	
Description:	Constructed of durable chrome steel tubing Swivel casters Non-topple base Angled rails for easy ball removal		
ADDITIONAL INFORMATION			

